

3 Watt Cellular T/R and Antenna Changeover Switch DC - 3.0 GHz

Rev. V5

Features

- Low Cost Plastic SOT-26 Package
- Low Insertion Loss: < 0.6 dB @ 1900 MHz
- Low Power Consumption: <20 μ A @ +3V
- Very High Intercept Point: 53 dBm IP3
- Both Positive and Negative 2.5 to 8 V Control
- For CDMA, W-CDMA, TDMA, GSM, PCS and DCS Applications

Description

M/A-COM's SW-425 is a GaAs monolithic switch in a low cost SOT-26 surface mount plastic package. The SW-425 is ideally suited for applications where very low power consumption (<10 μ A @ 5V), low intermodulation products and very small size are required. Typical applications include Internal/External antenna select switch for portable telephones and data radios. In addition, because of its low loss, good isolation and inherent speed, the SW-425 can be used as a conventional T/R switch or as an antenna diversity switch. The SW-425 can be used in power applications up to 3 watts in systems such as cellular PCS, CDMA, W-CDMA, TDMA, GSM and other analog/digital wireless communications systems.

The SW-425 is fabricated using M/A-COM's 0.5 micron gate length GaAs PHEMT process. The process features full chip passivation for increased performance and reliability.

Ordering Information¹

Part Number	Package
SW-425 PIN	Bulk Packaging
SW-425TR	1000 piece reel

1. Reference Application Note M513 for reel size information.

Absolute Maximum Ratings²

Parameter	Absolute Maximum
Input Power (0.5—3.0 GHz) 3 V Control 5 V Control	+36 dBm +38 dBm
Operating Temperature	-40°C to +85°C
Storage Temperature	-65°C to +150°C

2. Exceeding any one or combination of these limits may cause permanent damage to this device.

Functional Diagram

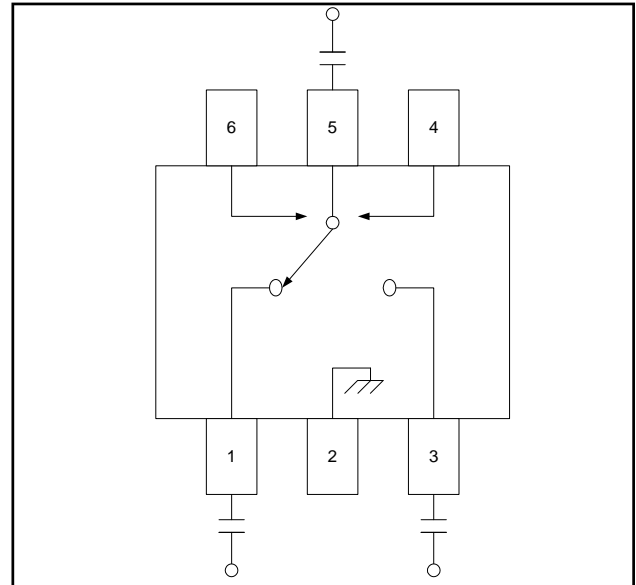

Pin Configuration

Pin No.	Function	Pin No.	Function
1	RF1	4	VB
2	Ground	5	RF Common
3	RF2	6	VA

Truth Table

Mode (Control)	Control A	Control B	RFC - RF1	RFC - RF2
Positive ⁴	0 \pm 0.2 V +2.5 to +8 V	+2.5 to +8 V 0 \pm 0.2 V	Off On	On Off
Positive/ Negative ^{3,4}	-Vc \pm 0.2 V +Vc	+Vc -Vc \pm 0.2 V	Off On	On Off
Negative ⁵	0 \pm 0.2 V -2.5 to -8 V	-2.5 to -8 V 0 \pm 0.2 V	On Off	Off On

3. External DC blocking capacitors are required on all RF ports. 39 pF capacitors can be used for positive control voltage.

4. [-VCTL], VCTL < 8 V

5. If negative control is used, DC blocking capacitors are not required on RF ports.

3 Watt Cellular T/R and Antenna Changeover Switch DC - 3.0 GHz

Rev. V5

Electrical Specifications: $T_A = +25^\circ\text{C}$

Parameter	Test Conditions	Units	Min	Typ	Max
Insertion Loss	DC - 1 GHz	dB	—	0.4	0.5
	1 - 2 GHz	dB	—	0.55	0.65
	2 - 3 GHz	dB	—	0.7	0.8
Isolation	DC - 1 GHz	dB	18	20	—
	1 - 2 GHz	dB	13	15	—
	2 - 3 GHz	dB	10	12	—
VSWR	DC - 3 GHz	Ratio	—	1.2:1	1.4:1
P1dB (3 V supply)	500 MHz - 3 GHz	dBm	32	34	—
P1dB (5 V supply)	500 MHz - 3 GHz	dBm	34	36	—
Input IP2	Two-Tone, 5 MHz spacing, +10 dBm (+13 dBm total) $V_{CTL} = 3\text{ V}$ 0.9 GHz	dBm	62	70	—
Input IP3	Two-Tone, 5 MHz spacing, +10 dBm (+13 dBm total) $V_{CTL} = 3\text{ V}$ 0.9 GHz	dBm	48	53	—
2nd Harmonics	Pin 30 dBm [$V_{CTL} = 3\text{ V}$]	dBc	65	70	—
	Pin 33 dBm [$V_{CTL} = 5\text{ V}$]	dBc	65	75	—
3rd Harmonics	Pin 30 dBm [$V_{CTL} = 3\text{ V}$]	dBc	45	48	—
	Pin 33 dBm [$V_{CTL} = 5\text{ V}$]	dBc	65	75	—
Trise, Tfall	10% to 90% RF, 90% to 10% RF	ns	—	60	—
Ton, Toff	50% Control to 90% RF, Control to 10% RF	ns	—	20	—
Transients	In-Band	mV	—	20	—
Gate Leakage Current	$V_{CTL} = 3\text{ V}$	μA	—	10	20

SOT-26

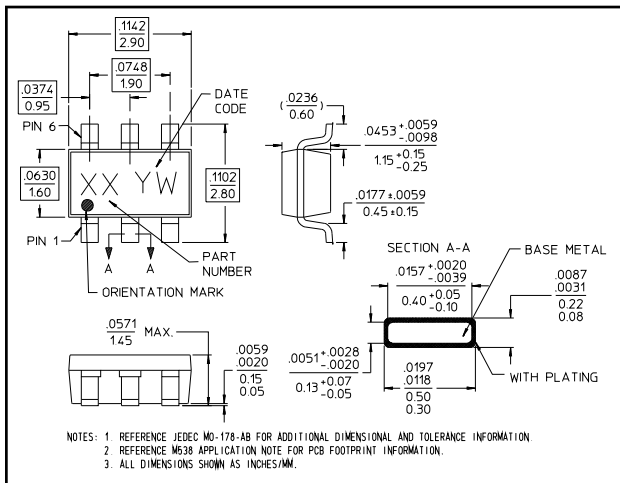

Handling Procedures

Please observe the following precautions to avoid damage:

Static Sensitivity

Gallium Arsenide Integrated Circuits are sensitive to electrostatic discharge (ESD) and can be damaged by static electricity. Proper ESD control techniques should be used when handling these devices.

Typical Performance Curves

Insertion Loss

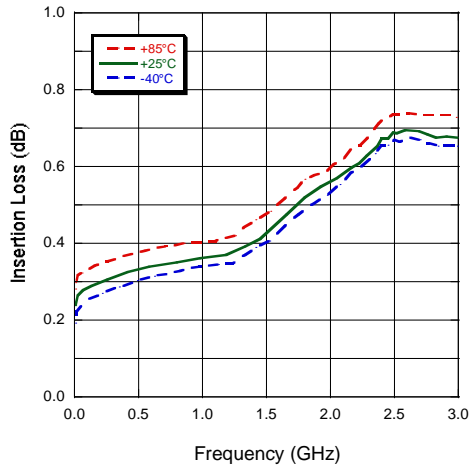

Isolation

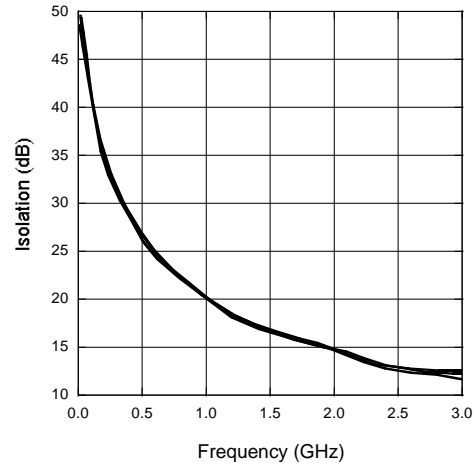

VSWR

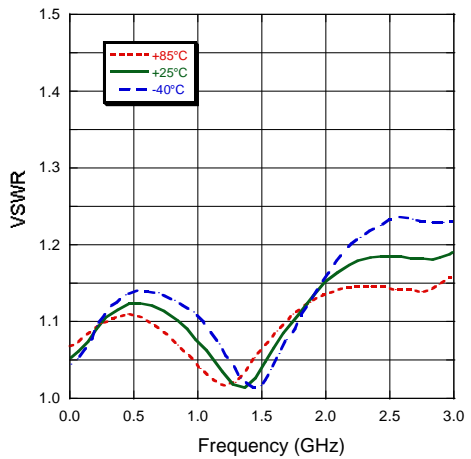

Input Compression Point vs. V_{CTL} @ 900 MHz

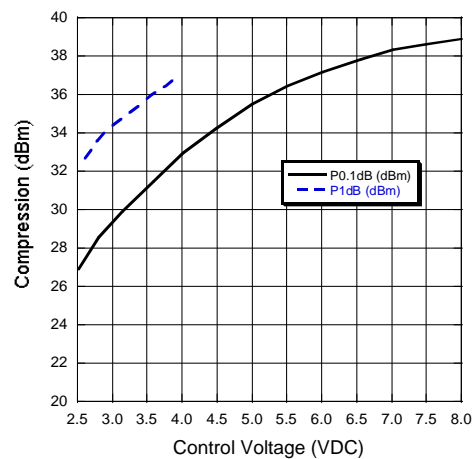

2nd Harmonic vs. V_{CTL} @ = 900 MHz

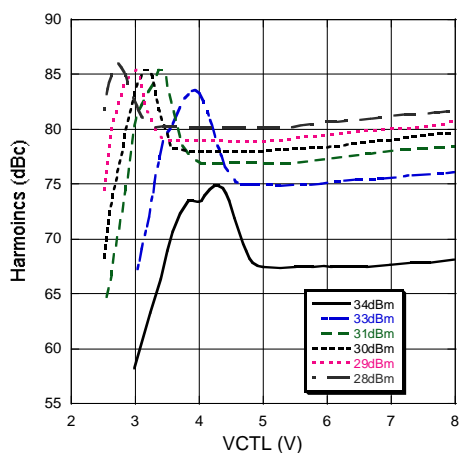

3rd Harmonic vs. V_{CTL} @ = 900 MHz

